

# ALUONE

## TENDA



# ALUONE TENDA

Sistema di copertura, da applicare a strutture esistenti, composto da guide in alluminio laccato e pacco telo.

- 1 FRANGITRATTA POSTERIORE
- 2 FRANGITRATTA INTERMEDIO
- 3 FRANGITRATTA FRONTALE
- 4 STAFFA A PARETE
- 5 GUIDA
- 6 TETTINO
- 7 RULLO TRASMISSIONE
- 8 TRAVE MOTORE/TETTINO



## INFORMAZIONI TECNICHE

Struttura portante realizzata interamente con profili in alluminio estruso con matrici a disegno

Tenda richiudibile ad impacchettamento realizzata con frangitratta in alluminio estruso con lega primaria UNI 6060

Classe di resistenza al vento 6

Profili verniciati a base di resina poliestere resistente ai raggi UV

Viteria completamente in acciaio inox

Carrelli di scorrimento con cuscinetti radiali a sfera

Pulegge e ruote dentate in nylon

Cinghia di trasmissione in poliuretano con anima in acciaio

Movimentazione con motore radio integrato con controllo automatico della tensione del telo e radiocomando di serie

Meccanica testata su 3000 cicli di apertura/chiusura equivalenti a 18000 metri e 4 anni di utilizzo

Di serie tessuto in poliestere resistente alle sollecitazioni meccaniche con spalmatura nera all'interno, ignifugo classe 2 secondo le norme italiane RF 1/75 e 3/77

Possibilità di ancoraggio con staffe a nicchia, a parete, frontali

Tenda con frangitratta in alluminio estruso verniciati Bianco RAL 9010 o Avorio RAL 1013 in abbinamento al telo, DR703 a richiesta

Guarnizione salvagoccia di serie

Tettino realizzato in resina bicomponente ondulata; colori di serie Bianco o Avorio in abbinamento al telo, non verniciabile in altre colorazioni; rifiniture perimetrali in alluminio in tinta con il colore della struttura

La formazione di condensa sul telo non è da considerarsi difetto, si tratta di un fenomeno naturale

La tenda verrà fornita con telo preassemblato fino a 500 cm salvo diverse indicazioni

## COLORI TESSUTO DI SERIE



## COLORI TESSUTO OPTIONAL (calcolare su area effettiva pergola)



## COLORI TETTINO



## COLORI FRANGITRATTA



## COLORI STRUTTURA DI SERIE



## ALTRI COLORI STRUTTURA



TEMPI DI CONSEGNA PER TESSUTI E COLORI STRUTTURA NON DI SERIE: 30 giorni lavorativi dalla conferma d'ordine

## MOTORE DI SERIE

Motore e telecomando 1 canale di serie CHERUBINI. Motore optional radio SOMFY e telecomando SITUO 1 CANALE

## AUTOMATISMI

LAVORAZIONI PARTICOLARI

LED

## ATTACCHI (optional)

## ATTACCHI (optional)

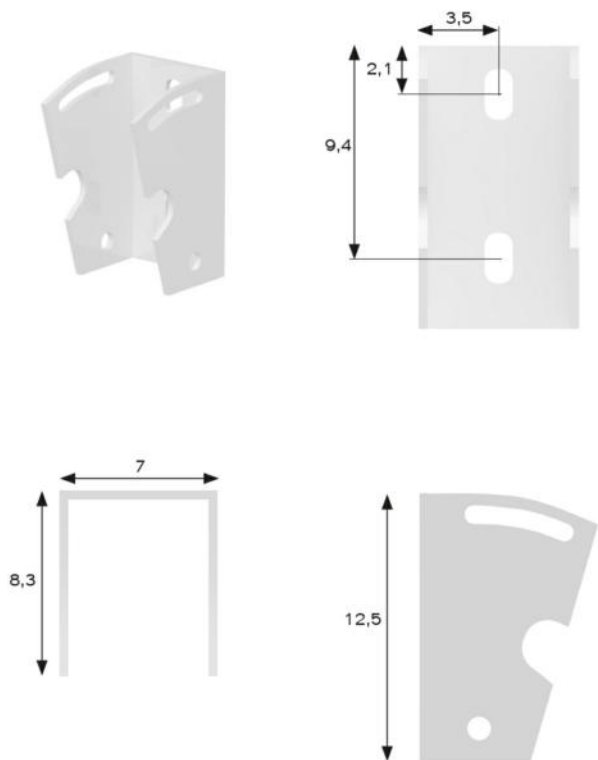

STAFFA A PARETE PER GUIDA

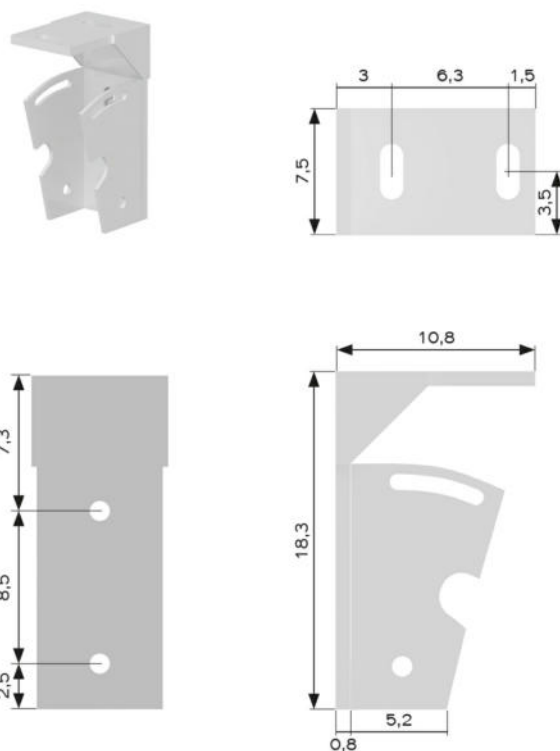

STAFFA A SOFFITTO

## PARTICOLARI ATTACCHI

## DETTAGLI

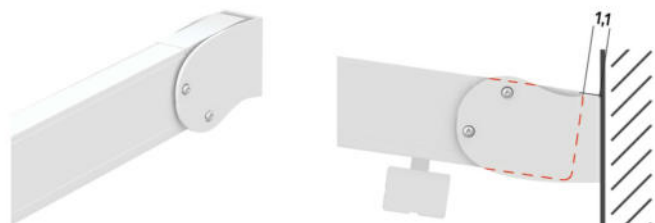

ATTACCO FRONTALE



ATTACCO IN NICCHIA

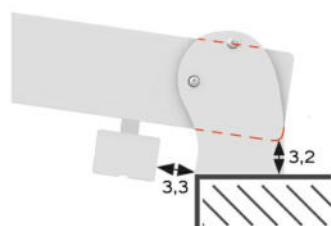

ATTACCO A TERRA

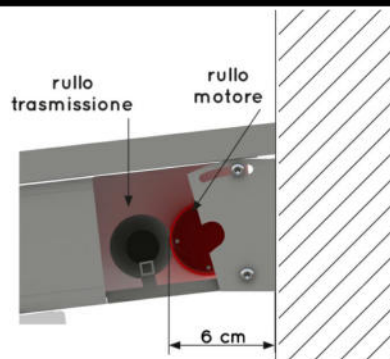

SPAZIO TRA RULLO DI TRASMISSIONE E PARETE

TIPI DI ATTACCO

## INGOMBRO TELO



## INGOMBRO TETTINO

⑥



SPORGENZA TENDA

PROFONDITA' TETTINO (P)

da 150 a 250

60 cm

da 251 a 400

75 cm

da 401 a 550

85 cm

da 551 a 650

100 cm

## POSIZIONAMENTO MOTORE

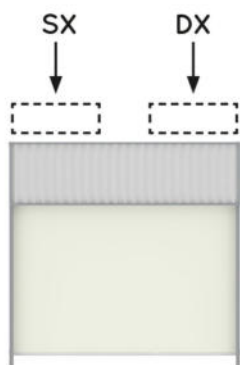

1 MODULO

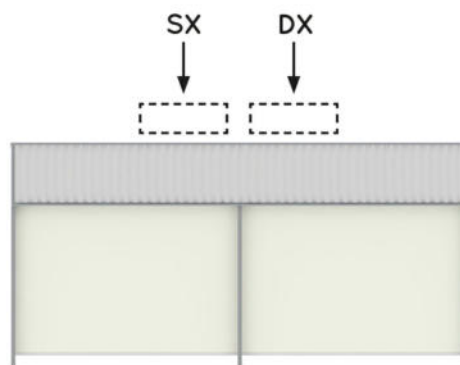

2 MODULI

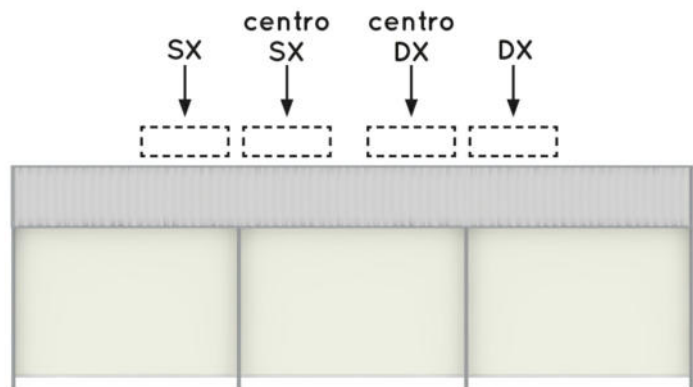

3 MODULI



IMPORTANTE valori del numero dei frangitratta possono variare in funzione della pendenza

## TABELLE PENDENZA

1 MODULO LxS max - 500x700 cm

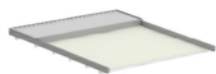

SPORGENZA	1 CAMPATA	LARGHEZZA							N. FRANGITRATTA (Indicativi)
		200	250	300	350	400	450	500	
150	9/7	11/8	13/10	15/11	17/12	19/14	20/15	3	
200	12/9	15/11	18/13	20/15	22/17	25/19	28/21	4	
250	15/11	19/14	22/17	25/19	29/21	32/23	35/26	5	
300	20/14	23/17	27/20	31/23	35/26	39/29	43/32	6	
350	22/17	27/20	32/23	36/27	41/30	46/34	50/37	7	
400	26/19	32/23	37/28	42/31	47/35	53/39	59/43	7	
450	31/23	36/27	42/31	48/36	54/40	60/45	66/49	8	
500	34/25	41/30	47/35	54/40	60/45	67/50	74/55	9	
550	38/28	46/34	53/39	60/45	68/50	74/55	82/61	10	
600	44/32	51/38	59/43	66/49	74/55	83/61	90/67	11	
650	47/35	56/41	64/47	73/54	82/61	90/67	99/73	12	
700	53/39	61/45	70/52	79/58	88/65	98/72	107/79	12	

2 MODULI LxS max - 900x700 cm

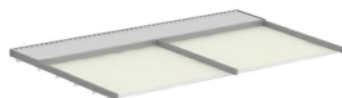

SPORGENZA	2 CAMPATE	LARGHEZZA								N. FRANGITRATTA (Indicativi)
		550	600	650	700	750	800	850	900	
150	14/11	15/12	16/13	17/13	19/15	20/16	20/16	21/17	3	
200	19/15	20/16	21/17	23/19	24/19	26/21	28/22	29/23	4	
250	23/19	25/20	27/22	29/23	31/25	33/26	34/28	36/29	5	
300	29/23	31/25	33/26	35/28	37/30	39/31	42/33	44/35	6	
350	33/27	36/29	39/31	41/33	44/35	47/37	49/39	52/42	7	
400	39/31	42/33	45/36	47/38	50/40	54/43	57/45	60/48	7	
450	45/36	47/38	51/41	54/43	58/46	60/48	64/51	67/54	8	
500	50/40	54/43	58/46	60/48	64/51	68/54	72/57	75/60	9	
550	56/45	60/48	63/51	68/54	72/57	75/60	79/63	83/66	10	
600	61/49	66/53	70/56	74/60	78/62	83/66	87/70	91/73	11	
650	68/54	73/58	77/62	81/65	86/68	90/72	95/76	100/80	12	
700	74/60	79/63	84/67	88/71	93/74	98/78	103/83	108/86	12	

3 MODULI LxS max - 1300x700 cm

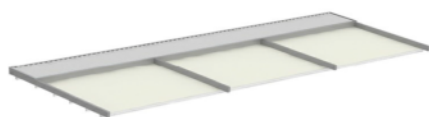

SPORGENZA	3 CAMPATE	LARGHEZZA								N. FRANGITRATTA (Indicativi)
		950	100	1050	1100	1150	1200	1250	1300	
150	15/12	16/13	16/13	17/14	18/15	19/16	20/16	20/16	3	
200	20/16	20/17	21/18	23/20	24/20	25/21	26/22	27/23	4	
250	25/21	26/22	28/23	29/24	30/25	32/27	33/27	33/28	5	
300	31/26	33/27	33/28	35/30	36/30	38/32	39/33	41/34	6	
350	36/30	38/32	40/34	42/35	43/36	45/37	47/39	48/41	7	
400	42/35	44/37	46/38	47/40	50/42	52/44	54/45	56/47	7	
450	48/41	50/42	52/44	55/46	57/48	59/49	61/52	63/53	8	
500	54/45	57/48	59/49	61/52	63/53	66/55	69/58	71/59	9	
550	60/51	63/53	65/55	68/57	71/59	73/62	76/64	79/66	10	
600	66/55	70/59	73/61	75/63	78/66	81/68	84/70	87/73	11	
650	73/61	76/64	79/66	83/70	86/72	88/74	92/77	95/80	12	
700	79/66	83/70	86/73	89/75	93/78	97/81	100/84	103/87	12	

## RILIEVO MISURE

NOTA BENE: la misura in LARGHEZZA è considerata esterno guide. La misura in SPORGENZA è quella della guida già inclinata. La misura in SPORGENZA è quella della guida, qualsiasi sia l'inclinazione

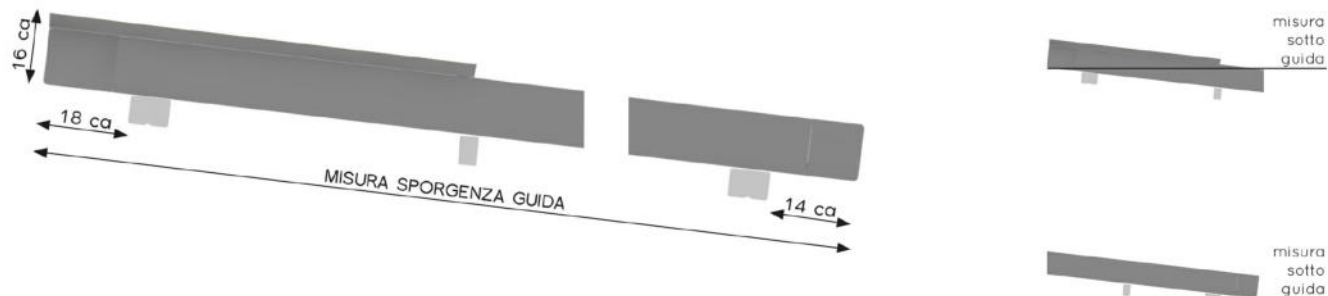

## VISTA LATERALE

PER IL MONTAGGIO CON STAFFE A PARETE CONSIDERARE 2 CM IN LARGHEZZA IN PIU' PER LATO, NECESSARI PER INGOMBRO VITERIA PER IL RILIEVO DELLA SPORGENZA FORNIRE LA MISURA FINITA DELLA GUIDA, SIA NEL CASO DI MONTAGGIO IN PIANO CHE INCLINATO

## TELO LASCO

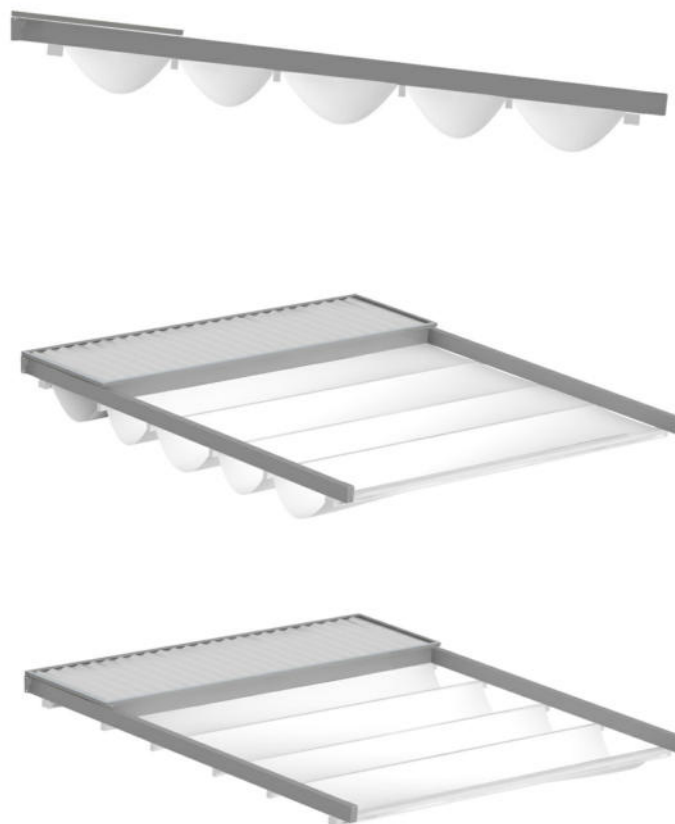

## GRONDA MOBILE

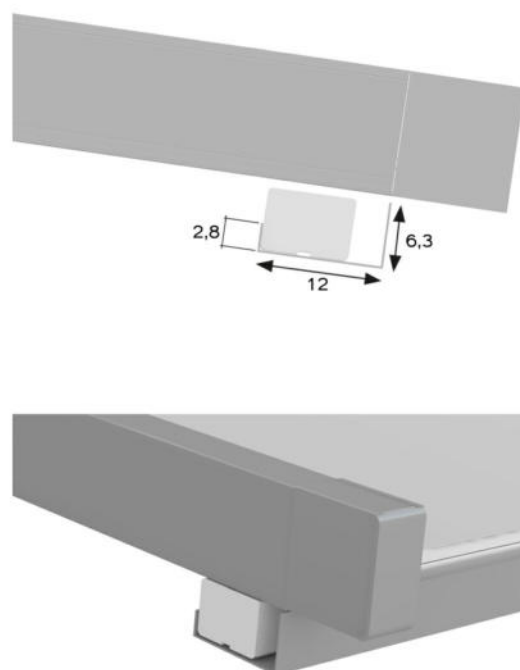

## COMPONENTI

